

Sistema K3+ / K3+ System

Sistema autoportante composto da ripiani e spalle.
Interamente in alluminio.

Freestanding system consists of shelves and shoulders.
All in anodized aluminium.



FINITURE / FINISHINGS

-  Alluminio anodizzato / Anodized aluminium
-  Bianco lucido RAL 9010 / White Gloss RAL 9010
-  Bianco opaco RAL 9010 / Mat White RAL 9010
-  Nero opaco RAL 9005 / Mat Black RAL 9005
-  Verde semilucido RAL 6003 / Semigloss green RAL 6003

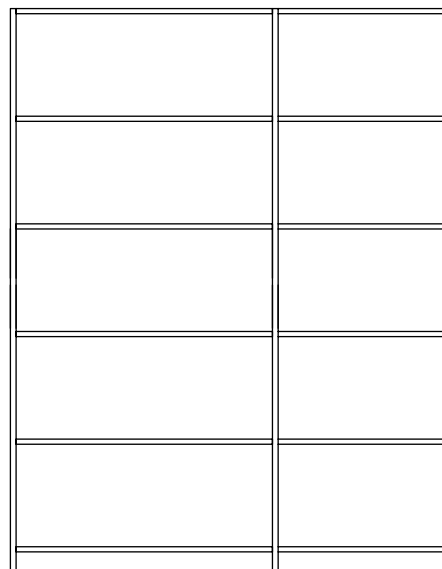

Sistema K3+ / K3+ System

PROFONDITA' 29 cm / 29 cm DEPTH

Ripiani / Shelves

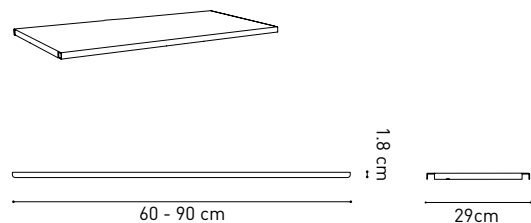

	60 cm	90 cm
Portata kg Load capacity kg	25	15
Capienza Libri Books capacity	30	45

Spalle / Uprights

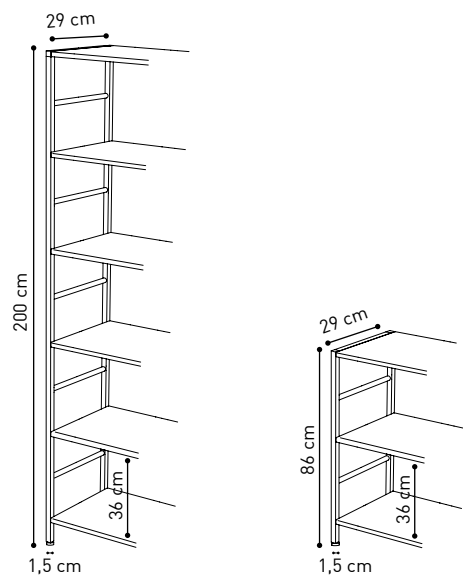

PROFONDITA' 36 cm / 36 cm DEPTH

Ripiani / Shelves

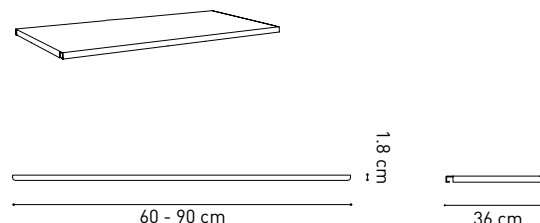

	60 cm	90 cm
Portata kg Load capacity kg	25	15
Capienza Libri Books capacity	30	45

Spalle / Uprights

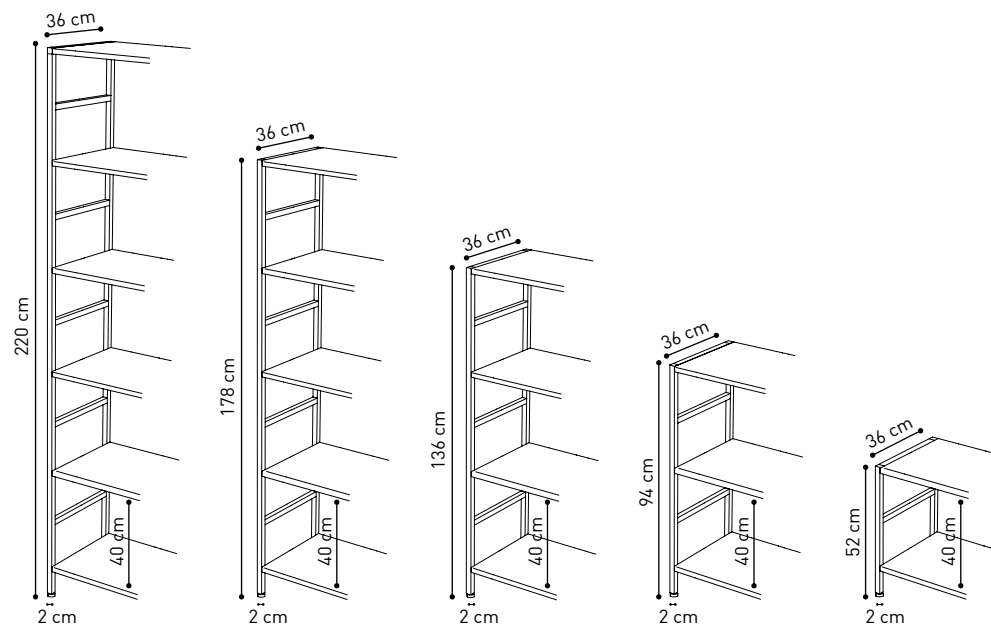

Sistema K3+ / K3+ System

Disponibile solo per profondità 36 cm /
Available only for 36 cm depth

www.kryptonite.com

Cassettiera doppia /
Double drawer

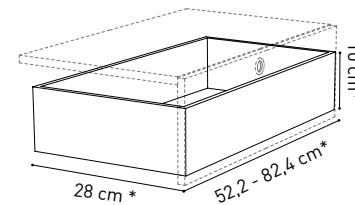
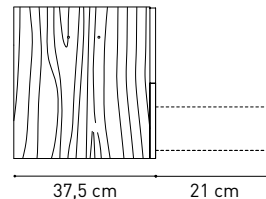
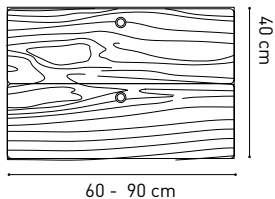
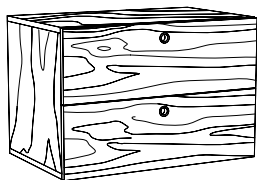

* Ingombro interno del cassetto
* Internal dimensions of the drawer

Cassettone /
Big drawer

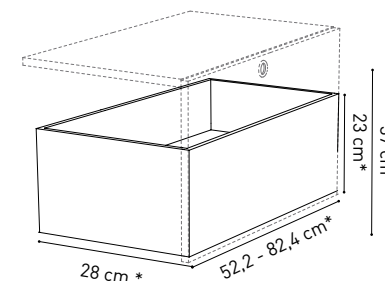
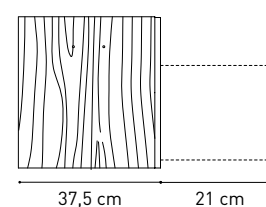
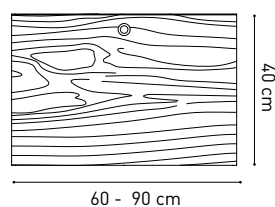
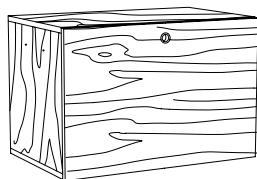

* Ingombro interno del cassetto
* Internal dimensions of the drawer

Ribaltina /
Unit with top down door

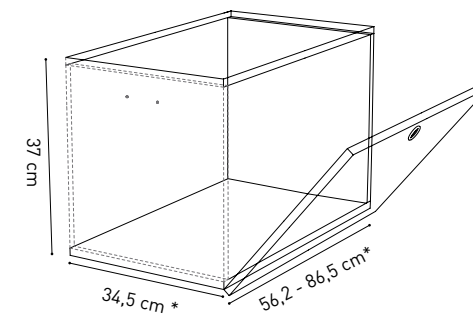
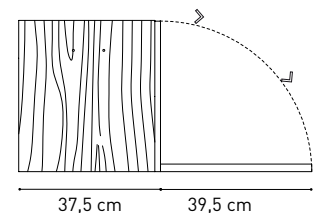
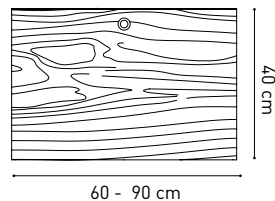
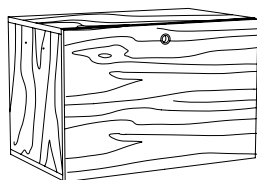

* Ingombro interno
* Internal dimensions

Pensile /
Unit with bottom up door

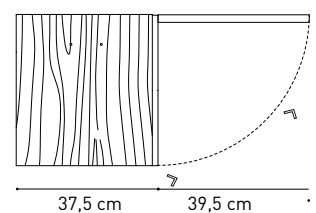
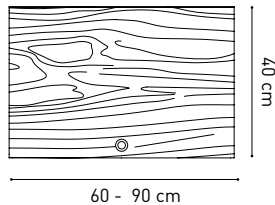
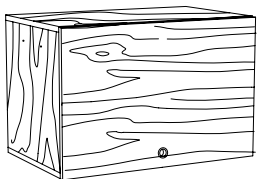

FINITURE / FINISHINGS

Marzo 2019  Legno Rovere / Oak Wood

 Legno Noce Canaletto / Walnut Wood

Sistema K3+ / K3+ System

Disponibile solo per profondità 36 cm /
Available only for 36 cm depth

www.kryptonite.com

Contenitore con antine /
Storage with door

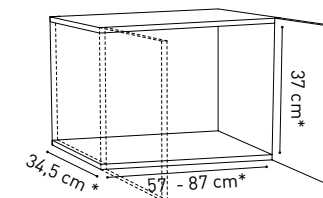
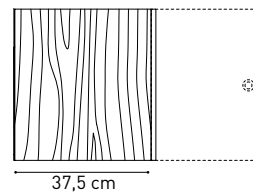
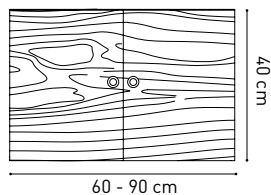
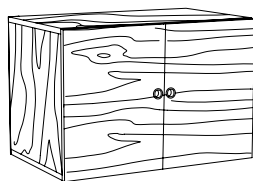

* Nella larghezza di 60 cm è prevista un'anta unica.
Al momento dell'ordine indicare il lato dell'apertura
In the 60 cm width it's provided only one door.
When ordering, indicate the side of the opening

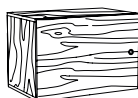

* Ingombro interno
* Internal dimensions

Contenitore h. 40 /
Storage unit h.40

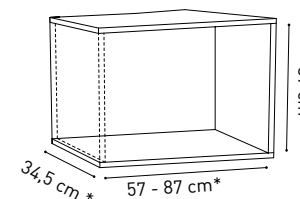
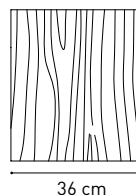
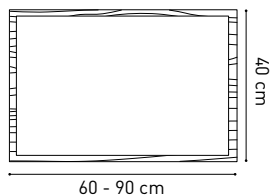
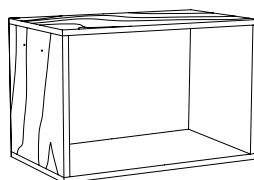

* Ingombro interno
* Internal dimensions

Contenitore con cassetto /
Storage unit with drawer

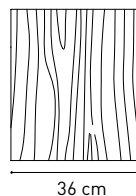
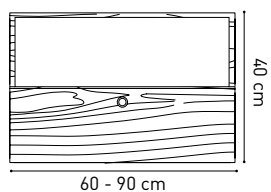
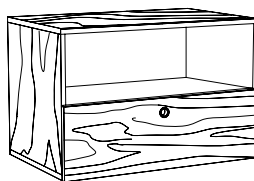

* Ingombro interno
** Ingombro interno Cassetto
* Internal dimensions
** Internal dimensions of the drawer

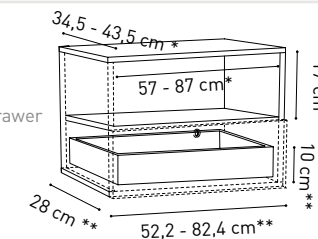

Piano* / Shelf*

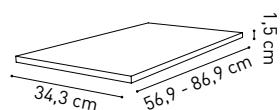

* Può essere inserito anche in un secondo momento
* It can be inserted later

Divisorio / Divider

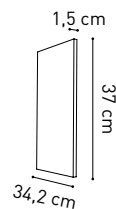

Contenitori compatibili / Compatible containers

